

SANYO

Pan-Focus PTZ Dome Cameras

VDC-DP9584S VCC-P9574S

PAN-FOCUS
Technology in Perspective

Vandal-Resistant
Day/Night Dome Camera
VDC-DP9584S

DAY NIGHT



Indoor Mini
Dome Camera
VCC-P9574S

**Built-in X2.6 Motorized Zoom
Pan-Focus Lens**

(f = 2.8–7.3 mm, F = 1.9–3.0) No focus adjustments



Pan-focus lens image



Varifocal lens image

- **PTZ Control (Coaxial and RS-485)**
- **520-TVL Resolution**
- **Built-in UTP Video Transmission Connectivity**
- **PTZ Control & Remote Camera Setting by VAC-70**
- **Vandal-Resistant***
- **IP66 Rated Enclosure***

*VDC-DP9584S

Made in Japan

Comparative images are representations only.

The products introduced here are manufactured in Japan utilizing advanced technologies and quality control.

Dome cameras with PTZ functions and a pan-focus lens for high-precision surveillance of wide areas



1/4" Color CCD DSP High-Resolution
Day/Night Vandal-Resistant
PTZ Dome Camera

VDC-DP9584S



DAY NIGHT

Focuses on all objects simultaneously with x2.6 pan-focus lens

When using a varifocal lens, objects in front of and behind the main focus point appear blurred. This has led to the development of deep-focus technologies allowing simultaneous focusing on all objects in the field of view. Early research by SANYO has resulted in successful product development of a x2.6 pan-focus lens offering a picture with a greater depth of field. Now clearer pictures, even of distant objects, can be achieved with cameras for surveillance applications.



Pan-focus lens image

- Clear focus on entire viewing area with great depth of field
- No focus adjustments
- Remote zoom adjustment via SSP system controller, VAC-70 or DVR.*

*DSR-5016, DSR-3716/3709



Varifocal lens image

- Clear focusing on a specific area
- Manual focus adjustments
- Manual zoom adjustments

PAN-FOCUS

Technology in Perspective

Blending easily with their surroundings, the dome cameras in widespread use at sites such as public facilities and retail premises are now equipped with PTZ functions. Two types—the VDC-DP9584S, offering strong resistance to shock, and the VCC-P9574S, offering superior cost performance—allow you to configure an effective surveillance system in response to the application and the environment of use.



1/4" Color CCD DSP
High-Resolution
PTZ Dome Camera

VCC-P9574S

16 Preset Positioning and Sequential Monitoring Functions

Up to 16 preset positions (with different settings for pan, tilt and zoom) can be registered for a single VDC-DP9584S or VCC-P9574S. A simple key entry to a controller allows you to easily switch to the scene you want to monitor. Auto-pan monitoring can be also be programmed by designating two end points on a horizontal plane.

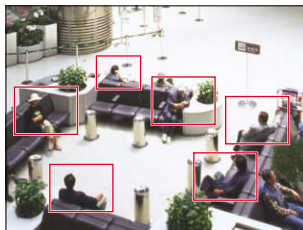

PTZ Operations

Both the VDC-DP9584S and VCC-P9574S come with a PT mechanism and allow panning of 335 degrees (110 degrees*) and tilting of 90 degrees (90 degrees*) to reduce blind spots in the surveillance area. When particular angles are preset on the camera (up to sixteen points), it moves to each position quickly at the speed of 120 deg/sec. max. for both panning and tilting. Combining these features with the motion detector, it is possible to catch all actions taking place in the area.

*For wall-mounted cameras

Photos of VDC-DP9584S

Ceiling mounting

Panning	0 to 335°
Tilting	0 to 90°

Wall mounting

Panning	-55 to 55°
Tilting	0 to -90°

Built-in Communication Board

SSP + Twisted pair board

Communication protocol:

Coaxial control: SSP / H-SSP / PELCO-C

RS485: SSP / H-SSP / PELCO-D

 Twisted pair terminal (CAT 5) for video signal:
NVT built-in UTP video

SSP (RS-485) compatible

By using SSP (SANYO Security Serial Protocol), cameras and DVRs can be controlled with just one controller over a daisy chain connection up to a maximum of 254 devices. The maximum cable length (total length of the daisy chain path) is 1200 m (400 feet).

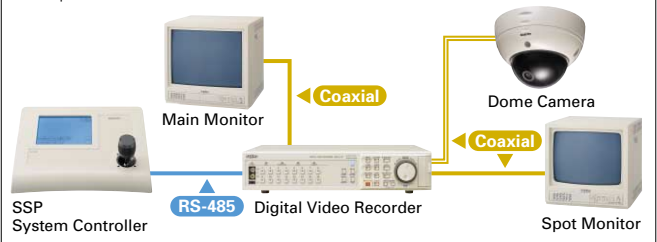

Adjustment via VAC-70 Control Unit (Sold Separately)

Connection of the VAC-70 control unit allows adjustment of pan/tilt, angle of view, motion detector, backlight compensation and other functions from in front of a monitor. The lens angle can be adjusted directly via a control switch inside the camera housing.

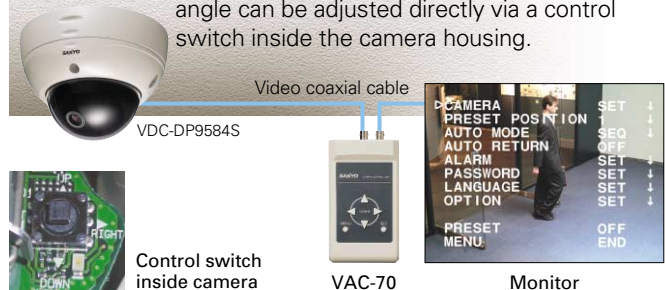

520 TV Line Resolution

Featuring SANYO's DSP circuitry and a high performance 1/4-inch CCD for horizontal resolution of more than 520 TV lines and superior color reproduction. Sharp, crisp images are delivered for greater precision in surveillance under a varied range of conditions.



Super high resolution at 520 TVL



Standard resolution

Intelligent Backlight Compensation

The VDC-DP9584S and VCC-P9574S feature two selectable backlight compensation modes: multi-spot metering (applied to the whole screen) and center-zone metering (applied to the central portion only).

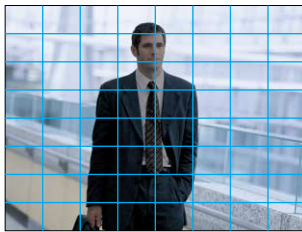

Multi-spot metering measures luminous intensity in 64 areas on screen to enable optimal backlight compensation even for peripheral and moving objects.



Built-in Electronic Shutter

A high-speed electronic shutter that is internally switchable for eight modes using a DIP switch allows adjustment increments from 1/60 to 1/10,000 sec.

Flexible Motion Detection

Sensing is performed by splitting the field of view into 16 areas. Movement and brightness levels within the picture are analyzed to accurately detect surveillance targets. Upon detection, the camera sends an alarm status signal and captures the object at zoom magnifications of up to x2.6. Fine adjustments of settings such as sensitivity, tracking time, zoom ratio and areas not requiring detection can also be made.

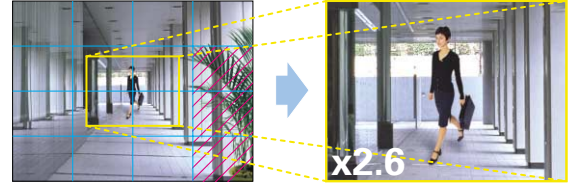

Areas with swaying trees or flickering light, etc. can be eliminated to avoid false alarms. Surveillance of the detected object can be conducted at a zoom magnification of x1.0, x1.4, x2.0 or x2.6.

Privacy Masking (Up to 8 Masks)

When there is a house or even an object as small as a window within the camera frame, it is possible to mask the area so that it will not appear on the monitor screen to protect other's privacy.



Up to 8 rectangular masks of arbitrary size can be set. These masking areas may be protected with a 4-digit (max.) password.

Operation on AC or DC Power Sources

The VDC-DP9584S and VCC-P9574S can operate on either 12 V DC (12-15V DC) or 24 V AC (60 Hz, and even at a tolerance of ±10%). Switching to the correct mode occurs automatically when power is supplied.

Functions Specific to the VDC-DP9584S

Intelligent Switching from Color to B/W

Selecting Color or B/W mode can be done automatically by the camera, or else manually. In addition, the user is allowed to change the switchover point from 1 to 10 lx (nominal) using the on-screen menu. The integration of color and high sensitivity B/W modes in one camera makes it a versatile tool for any surveillance need. It is truly an all-in-one camera.

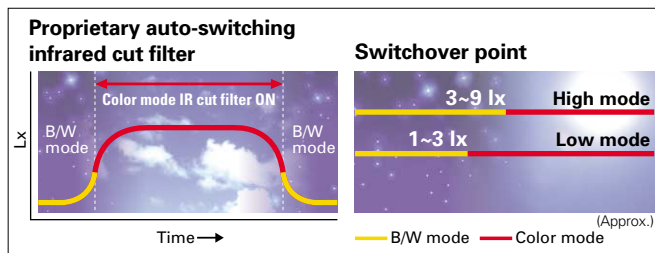

Tough Die-Cast Aluminum with Polycarbonate Dome

Housed in an exceptionally tough die-cast aluminum enclosure and a polycarbonate dome for extra durability under the most demanding of conditions. To protect against tampering, the screws of the enclosure cover have a unique shape that prevents it from being opened with ordinary tools.

IP66 Rated Weatherproof Design

The camera's protective enclosure safely meets the IP66 standard for resistance against debilitating water and dust.

High Sensitivity, Minimum Required Illumination

	B/W mode Gain: High	Color mode Gain: High
(F1.9, 20 IRE)	0.024 lx	0.48 lx
(F1.9, 50 IRE)	0.06 lx	1.2 lx

Installation, setup and operation made easy by simple, user-friendly design

Based on a development concept featuring a pan-focus lens for the realization of advanced surveillance functions together with enhanced operability and ease of installation. The VDC-DP9584S and VCC-P9574S increase lens function and camera maneuverability to simplify operation, save resources spent in installation and substantially heighten the available degree of freedom.

Easy interior access and setup

Inside the housings of the VDC-DP9584S and VCC-P9574S are camera units with integrated motors and lenses. Installation on ceilings or walls can be accomplished without difficulty and components such as the camera unit or an optional heater board* can be attached and detached easily in just a few steps.

*The heater board option can be mounted only in the VDC-DP9584S.



VCC-P9574S

Mounting and installation

The product pictured below is the VDC-DP9584S. Specifications differ slightly in the case of the VCC-P9574S. Please refer to the operating instructions supplied with each product for details.

The camera unit and board can be attached or detached by simply sliding the stopper.

Attach the camera unit to the bottom cover mounted at the surveillance point (ceiling or wall).

Set up and adjust according to the installation site.

Note: In the case of a wall mounted setup, hold down the clamp and release the hooks, then lift the camera unit and turn it 90° to attach it.

Ceiling mounting

Wall mounting

In the case of the VCC-P9574S

Push

Backside

Hold down the button on the side of the housing and detach the base plate from the back of the camera.

Bottom cover

Base plate

Ceiling

Wall

Set up and adjust according to the installation site.

Ceiling mounting

Wall mounting

Installation is completed by simply attaching the camera to the base plate.

VDC-DP9584S / VCC-P9574S

Specifications

Model No.	VDC-DP9584S	VCC-P9574S
Scanning system	NTSC standard 525 lines, 60 fields/sec.	
Image sensor	1/4" Interline transfer method CCD (3.6 x 2.7 mm)	
Number of pixels	Total: 811 (H) x 508 (V), Effective: 768 (H) x 494 (V)	
Horizontal resolution	More than 520 TV lines	
Day/Night mode	Auto (High/Low) / Color / B/W: External control	
Minimum illumination (approx.)	20 IRE	0.024 lx at max. AGC, with F1.9 lens, B/W mode 0.48 lx at max. AGC, with F1.9 lens, color mode
	50 IRE	0.06 lx at max. AGC, with F1.9 lens, B/W mode 1.2 lx at max. AGC, with F1.9 lens, color mode
Video output	1.0 Vp-p/75 ohms, composite	
Video S/N ratio	More than 50 dB (AGC Off)	
Backlight compensation	On (multi-spot metering [High/Normal], center-zone metering) / Off	
White balance	ATW / AWC / Manual (MWB) / Indoor (3200) / Outdoor (5600) / Fluorescent (FLUO)	
Gain control	High / Normal / Off	
Gamma	0.45 / 1	
Lens	Built-in motorized zoom pan-focus auto iris lens, f=2.8-7.3 mm (x2.6), F1.9 -3.0	
Electronic shutter	1/60, 1/100, 1/250, 1/500, 1/1000, 1/2000, 1/4000, 1/10000 sec.	
Motion detector	On / Off: Motion zoom function	
Privacy masking	On / Off: Max. 8 masked locations	
Alarm input	2 (NO / NC), Alarm preset function, Alarm zoom function	
Alarm output	1 (NO / NC)	
Character display	On / Off, Camera ID max. 16 characters, adjusting position	
Synchronizing system	Internal synchronization / Line lock	
Aperture compensation	High plus / High / Normal / Off	
Environmental conditions	Operating	Temperature: -10 to +50°C (+14 to +122°F), -30 to +50°C with heater Humidity: 35 to 90% RH
	Storage	Temperature: -20 to +70°C (-4 to +158°F), Humidity: within 70% RH
Menu	On screen display, password lock possible	
Auto mode	Sequential pan / Auto pan	
Panning range	Ceiling	0 to 335°
	Wall	-55 to 55°
P/T speed	Max. 120 deg/sec. at preset, 5-100 deg/sec. at manual	
Tilting range	Ceiling	0 to 90°
	Wall	0 to -90°
Preset positions	16	
Communication protocols	Coaxial control: SSP / H-SSP / PELCO-C RS-485: SSP / H-SSP / PELCO-D Video out: Coaxial cable / Category 5 LAN cable (NVT built-in UTP video) 	
Power supply	12-15V DC / 24V AC ±10%, 60 Hz	
Power consumption	9.0 W (without heater), 14.5 W (with heater)	7.0 W
Dimensions (Dia. x H)	ø162.0 x 114.8 mm (ø6.5 x 4.6 in.)	ø150.6 x 115.5 mm (ø6.0 x 4.5 in.)
Weight (approx.)	1.5 kg (3.3 lbs.) [without options]	640 g (1.4 lbs.) [without options]
Weatherproof standard	IP66	—
Regulatory	UL, FCC Class B	

Specifications subject to change without notice.

Dimensions

[Unit: mm (inch)]

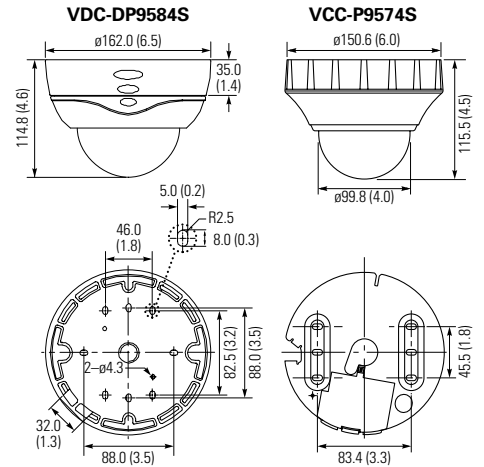

Options (sold separately)

VA-50H

Heater board

for VDC-DP9584S

Heater board providing protection from cold for camera unit. Allows use in -30°C operating environments (24 V AC only).

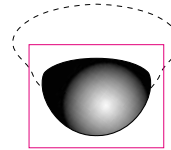

VVCZ-50

Smoked type

dome cover

for VCC-P9574S



VAC-70

Camera control unit

Pan-Focus Camera Lineup



VDC-DP7584

1/4" Color CCD
DSP High-Resolution
Vandal-Resistant
Day/Night
Dome Camera

VCC-P7574

1/4" Color CCD
DSP High-Resolution
Indoor Mini
Dome Camera

VCC-XZ200

1/4" Color CCD
DSP High-Resolution
Weatherproof
Day/Night Zoom Camera

Networkable Dome Cameras Soon to Be Available

VDC-DP9584N

1/4" Color CCD DSP High-Resolution
Vandal-Resistant Day/Night Network PTZ Dome Camera

VCC-P9574N

1/4" Color CCD DSP High-Resolution
Indoor Mini Network PTZ Dome Camera

Caution: Please consult the instruction manual to ensure safe and proper operation of the product.



DI Company of SANYO Electric Co., Ltd. obtained Quality Management System ISO 9001 and Environmental Management System ISO 14001 certifications.

Distributed by:

SANYO

SANYO Electric Co., Ltd.
www.sanyosecurity.com

©2006 SANYO Printed in Japan '06.6. MA.

SMS000